

Floralwall Cleaning Procedure – 6 page document

SP Case with Key Switch and Push Button

While Floraline floral display cases automatically change water in the tubes and vases at a predetermined time, a regular cleaning program must also be implemented. This will ensure many years of dependable service from your Floraline case, guarantee floral freshness and continued customer satisfaction with each and every purchase.

- ❖ **Weekly** - Clean the case exterior and the vases.
- ❖ **Monthly** - Flush and clean the water tubes.
- ❖ **Yearly** - Remove Tube #1 and clean the case bottom and drains.

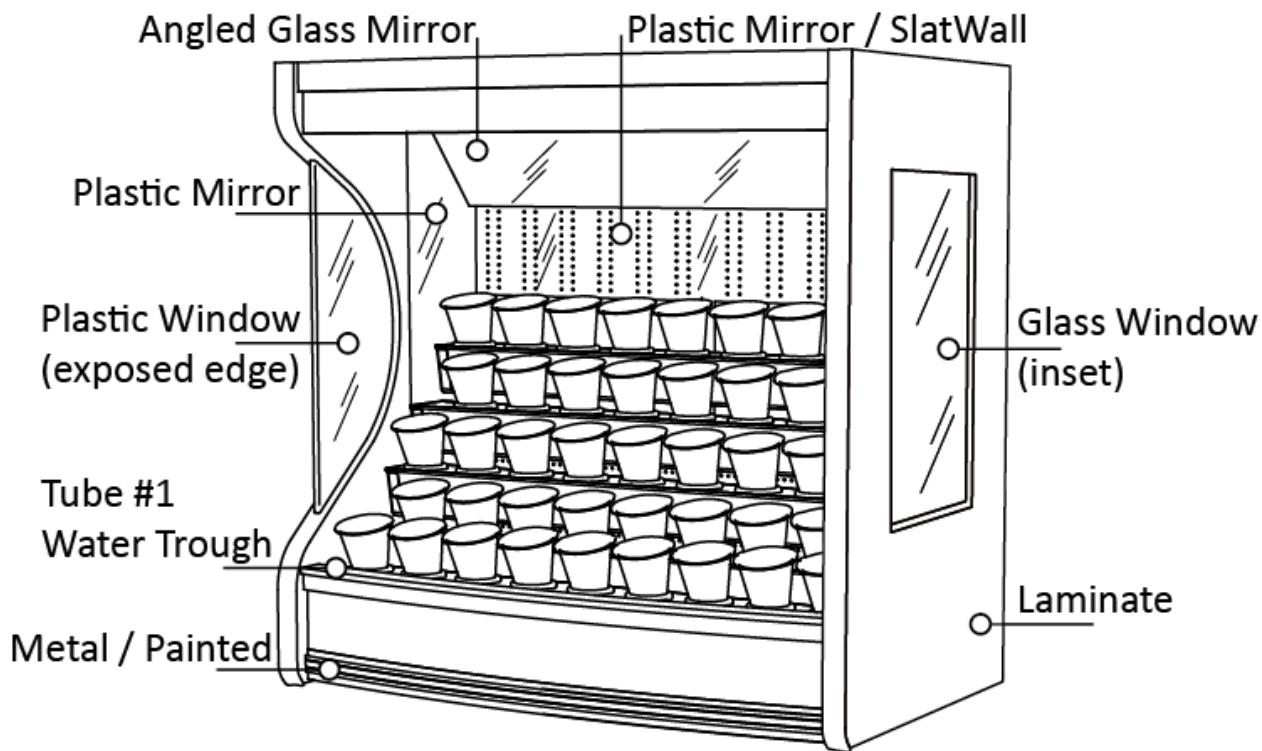

This illustration calls out the basic parts of the fixture that are referred to in this manual. Note: a plastic window will usually have an exposed edge while our glass windows will be fully enclosed on all edges. It is important to determine which type of window your case has for safe cleaning.

EACH WEEK

Cleaning the Case Surface

A mild soap and water solution applied with a soft cotton cloth or soft sponge is recommended for the **painted, metal and laminate surfaces** of the display cabinet. Ensure the bucket and cloth are clean and free of dirt or grit as these will cause scratching. **DO NOT USE CLEANERS THAT CONTAIN AN ABRASIVE MATERIAL.** Using abrasive cleaners will scratch and dull the cabinet's finish.

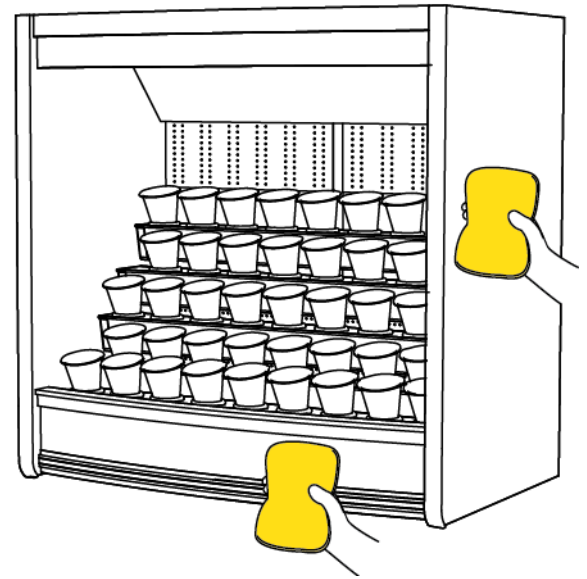

Cleaning Mirrored Plastic or Plastic Side Windows

Care must be taken to clean any mirrored plastics such as the case slat wall back and side panel mirrors to prevent scratching. Use the same cautions when cleaning any clear plastic windows that have been installed on the case. Never use paper towel or glass cleaning products on plastics. **Please review the detailed section, MIRROR MAINTANENCE, included with these instructions.**

Cleaning Glass Windows

Cases may contain true glass windows. These are installed on the side panels and have no exposed edges. Only glass windows may be cleaned with typical window cleaners.

Cleaning the Vases

A cleaning disinfectant and water solution applied with a soft cotton cloth or soft sponge is recommended. Wipe the vase inside and out to eliminate any residue. Ensure the bucket and cloth are clean and free of dirt or grit as these will cause scratching and bacterial contamination. A clean vase is critical to good floral health. Cleaning products especially formulated for use in the floral industry are available from your floral supply house. Please refer to them for help in choosing the correct product.

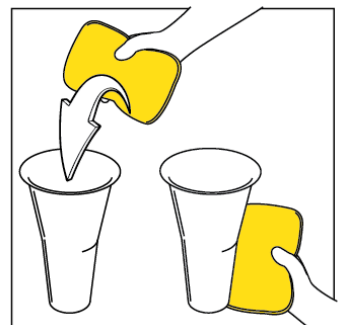

EACH MONTH

Flush and Clean Water Tubes

1. Insert and turn the key clockwise to engage the tube flush mode. The button light will change from **GREEN** (Normal Operation) to **RED** (Flush Mode). The key cannot be removed when in this position and the case will not re- fill.
2. Press and release the button to flush each row. Press the button once to flush row one. Press the button a second time to flush row two. Press the button a third time to flush row three and so on. The process will time out if left unattended but may be restarted at any tube. For example; to restart at tube #3, repeat step 1 then press the button three times. Tube #3 will start its flush cycle.
3. Insert a large sponge or cotton cloth through the hinged access door and vase holes on the top of the water tube and clean inside the tube.
4. To finish and refill, turn the key counterclockwise. The key can now be removed. The button light will turn **GREEN** indicating Normal Operation and water tube will refill. Note: You may hear a clicking sound from the pressure switch, this is normal.

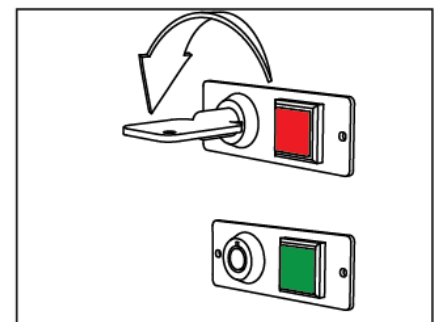
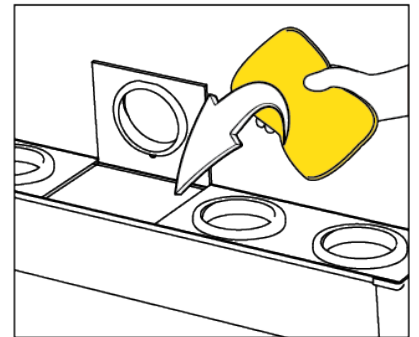
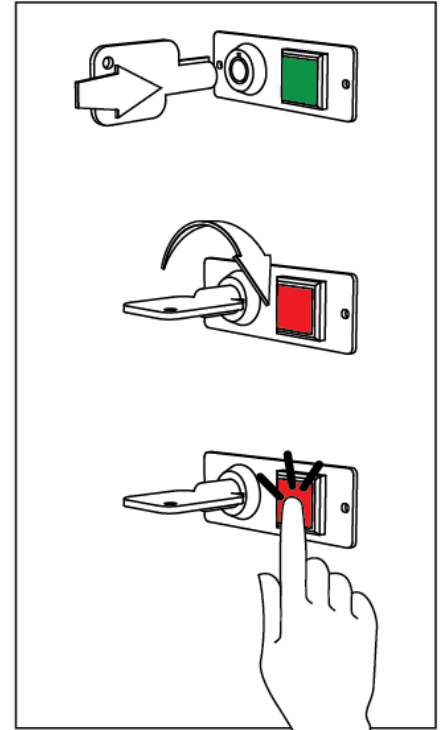

EACH YEAR

Removal of Tube Row #1 and Internal Case Cleaning

There are three connectors to the water tube that must be uninstalled before the tube can be removed.

1. Water Fill connection
2. Water Float connection
3. Water Drain connection

The Float connection is a simple male and female two prong plug.

The Fill and Drain will be connected with either of the fitting types shown below.



Cleaning Connections

TrueSeal™ Hose Connection

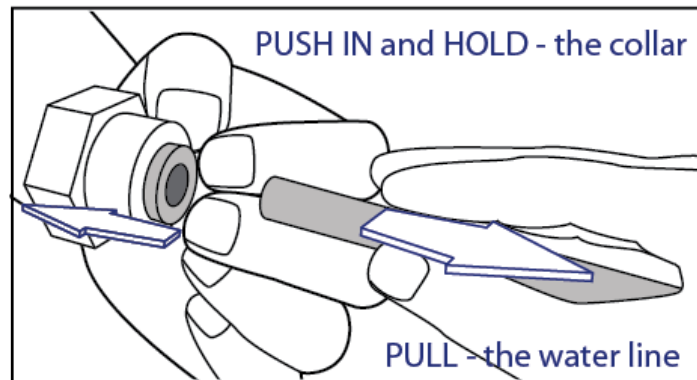
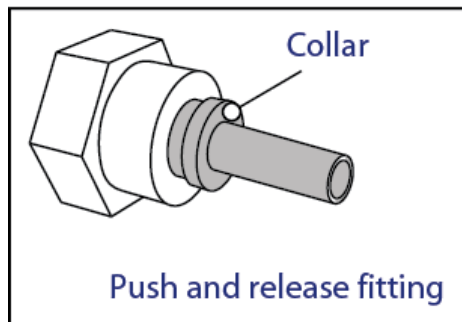

Fast-Tite® Hose Connection

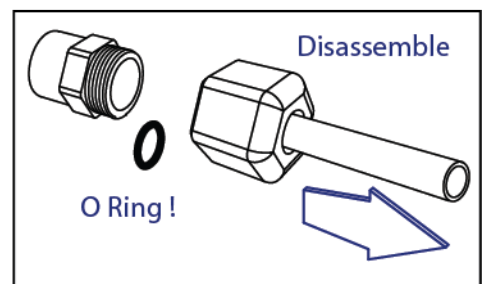
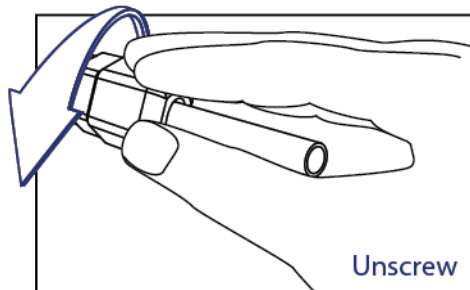
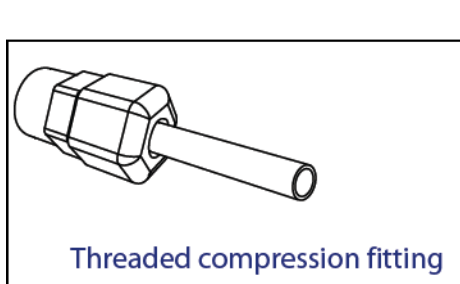

EACH YEAR

Removal of Tube Row #1 and Internal Case Cleaning

Flush water Tube #1 only to prepare the fixture for disassembly and cleaning.

1. On Tube #1 ONLY. Remove the fill fitting **BY HAND**.
2. On Tube #1 ONLY. Disconnect the float connection **BY HAND**, pulling it straight apart.
3. On Tube #1 ONLY. Remove the flush fitting **BY HAND**.
4. Lift Tube #1 out of the fixture and place it on a flat surface that will support it safely. Place it out of the way so as not to cause a trip hazard. It is advised to use two people to lift and carry the tube.
5. Inspect and clean the inside of the case sides, bottom and drains. A wet vacuum is ideal to remove any loose debris. A cleaning disinfectant and water solution applied with a soft cotton cloth is recommended to wipe down the inside of the case.
6. Replace Tube #1. Use two people to lift and carry the tube. Ensure that it is seated correctly in its supports and is level.
7. Reconnect the flush fitting, depress the fitting collar and ensure the water hose is fully inserted, release the collar. **BY HAND**
8. Reconnect the float connector so that both halves meet tightly. **BY HAND**
9. Reconnect the fill fitting, depress the fitting collar and ensure the water hose is fully inserted, release the collar. **BY HAND**.

The fixture is now ready to refill. Follow the restart procedures. Be sure to turn the key counter clock wise. Check for water leaks at the connection points.

This document and other support resources are available online at <http://floraline.com/Manuals.php>

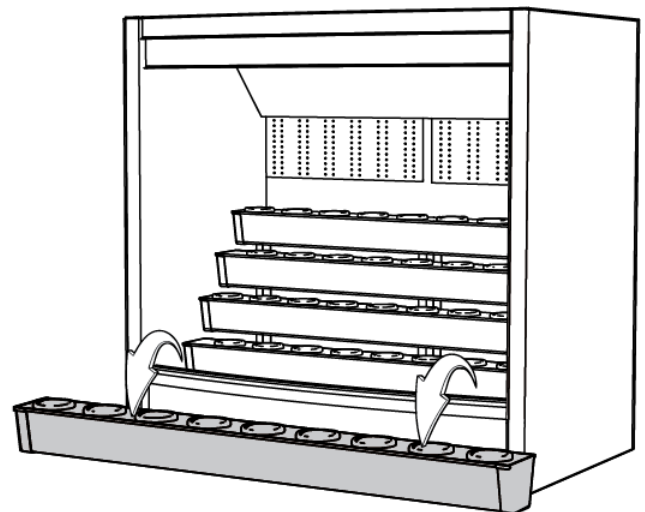
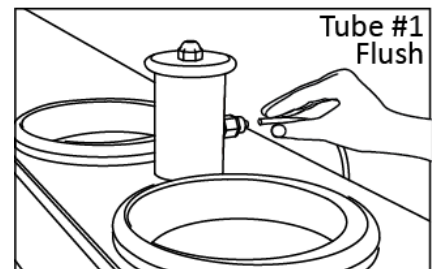
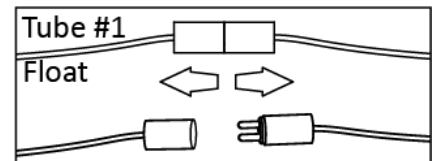
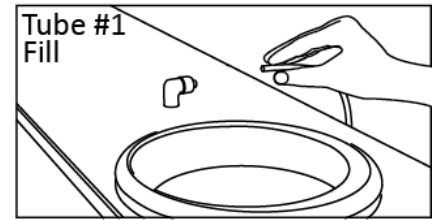



PLASTIC MIRROR MAINTENANCE - interior sides and slatwall

Each mirrored product is well protected by a durable paint backing and a removable masking on the front. If there is difficulty in removing the masking, use aliphatic naphtha, kerosene, or distilled alcohol to moisten the adhesive. **Do not use other chemicals or sharp objects to remove the masking.**

Cleaning, Polishing and Scratch Removal

For typical cleaning, dampen a soft cotton cloth in a mixture of clean water and mild dish soap. Ensure the bucket and cloth are clean and free of dirt or grit as these will cause scratching to the mirror. Use only light pressure to wipe the surface. **NEVER use aggressive scrubbing pressure, paper towels, window-cleaning sprays, kitchen scouring compounds or other chemicals to clean the mirror as these will all cause scratching or damage.**

If your mirror does become scratched, any repair is best left to the attention of a professional. In some cases repair is not possible and a damaged mirror may require new installation.

To remove grease, oil or tar deposits on the material, hexane, kerosene or aliphatic naphtha may be used applied with a soft cotton cloth and light pressure. **Do not use any chemicals if there is a painted or printed design on the mirror.**

Chemical Resistance

Like all plastic materials, mirrored acrylic will react when exposed to many chemicals. Factors such as fabrication stresses, exposure to loads, changing temperatures and the method of application can all influence the possible reaction. In all cases, care should be taken with any chemicals or solvents used near mirrored acrylic.

Below is a partial list of chemicals known to react with acrylic mirror; exposure to them should be avoided. BENZINE, ETHYL ALCOHOL, LACQUER THINNERS, KETONES, ESTERSTOLUENE, METHYL ALCOHOL, CARBON TETRACHLORIDE, ETHERS.

LAMINATE MAINTENANCE- exterior sides

To clean the surface, use a soft damp cotton cloth or sponge and a mild dish soap. Difficult stains such as coffee or tea can be removed using a mild household cleaner/detergent and a soft bristle brush, repeating as necessary. If a stain persists, use a paste of baking soda and water and apply with a soft bristled brush. Light scrubbing for 10 to 20 strokes should remove most stains. Although baking soda is a low abrasive, excessive scrubbing or exerting too much force could damage the decorative surface, especially if it has a gloss finish. Stubborn stains that resist any of the above cleaning methods may require the use of undiluted household bleach. Apply the bleach to the stain and let it stand no longer than two minutes. Rinse thoroughly with warm water and wipe dry. This step may be repeated if the stain appears to be going away and the color of the laminate has not been affected. **WARNING:** Prolonged exposure of the laminate surface to bleach will cause discoloration.

Special Tips

Always rinse laminate surfaces after cleaning. Failure to rinse after cleaning is the single greatest cause of damage to a laminate surface. Moisture can reactivate the smallest amount of cleaning solution remaining on the surface and result in permanently etched scars or discoloration. Always rinse thoroughly with clean water and a clean soft cotton cloth. **It is always recommended to test any new cleaning product first on an inconspicuous section of the case.**